

# Installation, Operation and Maintenance Instructions



## **VIBRATORY FEEDER MODEL HS-5**

**ERIEZ MAGNETICS** HEADQUARTERS: 2200 ASBURY ROAD, P.O. BOX 10608, ERIE, PA 16514-0608 U.S.A.  
*WORLD AUTHORITY IN ADVANCED TECHNOLOGY FOR MAGNETIC, VIBRATORY and METAL DETECTION APPLICATIONS*

---

# Introduction

This manual details the proper steps for installing, operating and maintaining the Eriez HS-5 Vibratory Feeder.

Careful attention to these requirements will assure the most efficient and dependable performance of this equipment.

If there are any questions or comments about the manual, please call Eriez at 814/835-6000 for Vibratory Feeder assistance.

# Table of Contents

## ERIEZ VIBRATORY FEEDER - MODEL HS-5

INSTALLATION .....	4
Mounting .....	4
Drives without Trays .....	4
Electrical Connections .....	4
OPERATION AND MAINTENANCE .....	5
Tuning Guide .....	5
Tuning by Plunger Adjustment .....	6
Tuning by Replacing Springs .....	6
Tuning for Non-standard Trays .....	7
Tuning for Different Conditions of Tray Loading .....	7
REPAIRS .....	7
Spring Replacement .....	7
Coil Replacement .....	8
The Hi-Vi Magnetic Drive Circuit .....	9
TROUBLESHOOTING .....	10
PARTS .....	12



# Installation

## MOUNTING

This Hi-Vi model should be mounted on a flat, stable surface in one of the two following ways:

### Positioned and Fastened

Fasten the unit to the desired surface with bolts or screws of proper size through the standard rubber isolators on the base. Use flat washers under the bolt heads.

### Positioned but Not Fastened

Install headless stud pins of proper size into the rubber isolators. Set the base (with the standard rubber isolators) into holes in a base plate. If the drive unit is equipped with the optional coil spring isolators, spring seats must be used.

## DRIVES WITHOUT TRAYS

Drive units are often supplied without trays for use with trays, chutes or tracks supplied by others. In this case the chute, track, tray or other equipment is bolted to the tray mounting plate supplied with the drive unit. Maximum tray weight for each drive is 3.0 pounds (1.36 kg). Make sure the drive unit is installed so the end containing the leaf springs is facing the direction of material flow (see Figure 1). The center of gravity of any components attached to the drive unit should be as close as possible to the drive unit's drive line (see Figure 1).

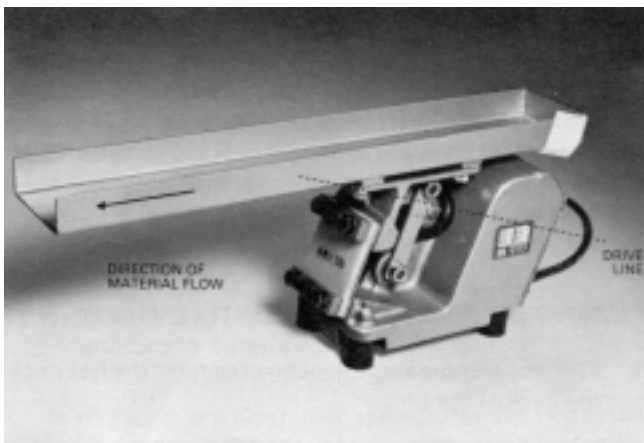

FIGURE 1

## ELECTRICAL CONNECTIONS

NOTE: The Eriez Vibratory Feeder is designed to be operated from an AC source. It cannot be operated from a DC source.

All wiring should conform to all applicable electrical codes.

1. Check the specifications of the power line to be certain that they are the same as those shown on the nameplate.
2. Connect the black and white wires in the feeder power cord to the power source or to the terminals in the control box marked "Output".
3. Connect the green wire to the ground or to the lug provided in the control box.
4. Connect the power line to the terminals in the control box marked "Line".
5. Connect the ground lug in the control box to a good earth ground (a cold water line is excellent).
6. On multiple drive feeders (two or more drives on one tray) all drives should be wired electrically in phase. The black wires from each power cord should be connected together and the white wires connected together.

YOU ARE NOW READY TO START YOUR VIBRATORY FEEDER.

### CAUTION: Operation from portable engine driven power plants.

Varying and unstable line frequency has an adverse effect on vibratory feeders because they are tuned mechanical devices, designed around either 50 or 60 cycle operating frequency. Shifts in the operating point due to changes in frequency cause higher than normal spring stress, striking and high line currents. When operating from portable engine-driven power plants, be certain that the engine is up to speed and all other loads are started and at running speed before starting the electromagnetic feeder.

The feeder should always be stopped first when the engine-driven power plant is shut down.

# Operation and Maintenance

## **Do not operate the unit with associated equipment touching any part of the unit.**

To start the feeder after all connections have been made, apply power to the line connected to the feeder. If a controller is used, operate the switch on the controller and adjust the output voltage to maximum by rotating the control knob to the full clockwise position. Usually (at ordinary room temperatures) the unit will take about two minutes to reach full steady-state displacement.

After full steady-state displacement has been attained, use the controller to adjust the unit to the desired feed rate.

No routine maintenance or lubrication is required, except that any accumulation of foreign matter should be periodically removed from between the tray-tiebar assembly and the body, and from between the body and the mounting surface, to prevent restriction of movement of the vibratory elements.

## **IMPORTANT NOTE:**

### **Special Trays and Attachments**

Eriez engineering service should always be consulted before undertaking the design or construction of special trays. Do not modify either standard or special trays as furnished by Eriez, or make attachments to these trays without first consulting us. Unauthorized modifications will void the warranty. (See Standard Tray Specifications.)

## **TUNING GUIDE**

### **General Information**

The tuning means is provided solely for the purpose of mechanically tuning the unit, with its tray, to the desired vibratory displacement at full voltage. HS-5 drive units supplied without trays are tuned by Eriez for use with a three-pound (1.36 kg) weight. If supplied with a tray, they are tuned for that specific tray and should require no further adjustment. However, if different trays or other components of a system are used, or if a striking condition occurs, a tuning adjustment of the air gap – the space between the two plungers – should be made using the following procedures.

In normal operation at full voltage, the total displacement for standard size trays, measured at the back of the tray, is .110" to .120" (2.8 mm to 3.0 mm). For trays substantially larger than standard this normal displacement range should be reduced. Refer to the serial number plate on your feeder for the amplitude that your unit was tuned for.

### **How to Measure Displacement**

Position an Eriez displacement sticker on the outer side of the tray, near the rear of the tray and at an angle of 25° from vertical (see Figure 2).

With unit operating observe where the fine gray lines on the displacement sticker meet. This point will be higher or lower as the displacement changes. Opposite the point where they meet, read amount of displacement

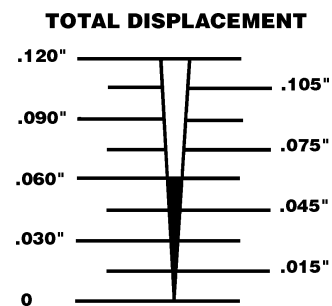
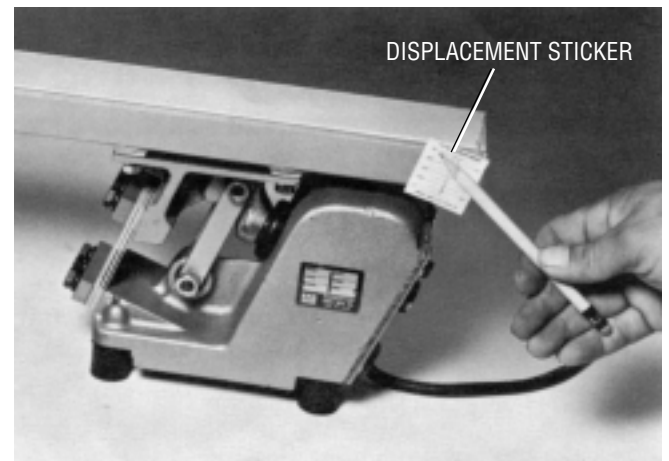

FIGURE 2

# Operation and Maintenance (cont.)

## TUNING BY PLUNGER ADJUSTMENT

1. With the tray mounted, loosen or remove the hex nut at the back of the unit.
2. Insert a screw driver into the slot of the plunger (see Figure 3) and turn it clockwise until the plunger hits the armature.
3. Back out the plunger by turning it counter-clockwise three full turns.
4. Replace and tighten the hex nut.
5. Check the deflection. See "How to Measure Displacement".

Eriez HS-5 units operate with a maximum tray stroke between .110" and .120" (2.8 mm and 3.0 mm). If the deflection sticker reading is more or less than this, further tuning can be done by turning the adjustable plunger. To decrease deflection, turn the plunger counter-clockwise; to increase deflection turn the plunger clockwise. If this air gap adjustment does not produce the desired performance, further tuning by replacing springs is necessary.

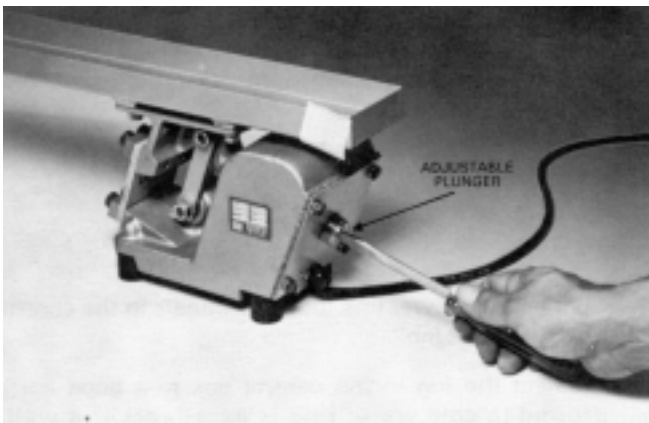

FIGURE 3

## TUNING BY REPLACING SPRINGS

To obtain the maximum desirable deflection, it may be necessary to add, subtract or substitute tuning spring leaves in the tuning spring stack (see Figure 4) at the front of the unit.

The following general rules, which apply only to the Feeder operating ideally on the "normal" side of its "tuning curve," should be borne in mind

when making tuning adjustments to increase or decrease the displacement:

1. To DECREASE the tray displacement, DECREASE the stiffness of the tuning springs.
2. To INCREASE the tray displacement, INCREASE the stiffness of the tuning springs.

If decreasing or increasing the tuning spring stiffness has an opposite effect, it means that the spring stiffness is great enough that the unit is operating on the "opposite" side of its tuning curve. The spring stiffness should be reduced until the behavior is in accordance with rules 1 and 2. The unit can then be properly tuned to the desired displacement.

As a guide to the stiffness of individual tuning springs, each spring is marked with a code number- example, 5-27. The first number (5) is the number of fiberglass plies in the spring. The following number (27) indicates the relative stiffness of the spring; the higher this number the stiffer the spring.

The total stiffness of the tuning spring stack is the sum of the relative stiffness numbers. By various combinations of different ply springs having different relative stiffnesses, practically any desired total stiffness can be obtained.

When tuning is completed, make sure the adjustable plunger lock nut is tightened down.

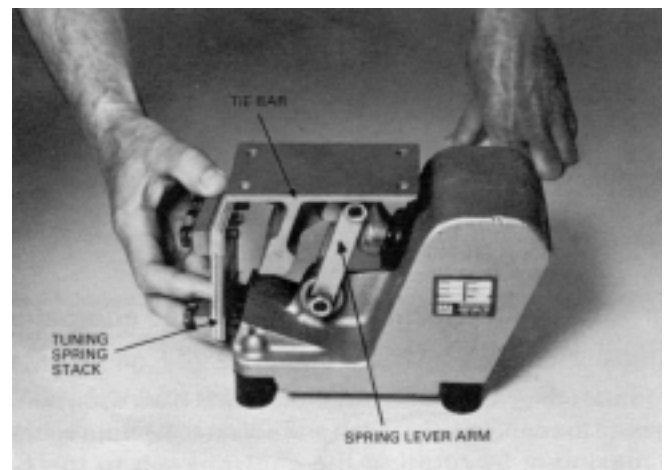

FIGURE 4

# Operation and Maintenance (cont.)

## TUNING FOR NON-STANDARD TRAYS

(Note: See "Special Trays and Attachments")

If it is necessary to tune the unit to an off-size or non-standard tray, follow this procedure:

1. Attach the tray, making sure that all lockwashers are in place and the fasteners tight.
2. Energize the unit at the nameplate voltage and frequency.
3. (a) During tuning if a hammering or striking noise occurs when the unit is turned off and on quickly, the displacement is well in excess of normal. Whether striking or not, if the displacement exceeds the normal range for that particular size of tray (see Tuning Guide-General Information), it must be reduced by substituting a tuning spring leaf or leaves of displacement and feed rate.  
  
(b) During tuning if the displacement at full voltage is below the nominal range for that

particular size tray, and greater displacement is desired, increase the tuning spring stiffness by substituting leaves of greater stiffness or by adding more leaves.

## TUNING FOR DIFFERENT CONDITIONS OF TRAY LOADING

Units with Eriez-built trays are factory tuned for normal displacement (approximately .110" to .120" [2.8 to 3.0 mm]) with light loading (light head load, light materials, limited depth of flow of heavier materials). Ordinarily this tuning will not need to be changed. In no case, however, should the unit be permitted to deflect more than .120" (3.0 mm) without load.

**CAUTION: A small amount of striking during tuning is permissible, but must not be allowed during regular operation since damage to the feeder can result.**

# Repairs

## SPRING CHANGE OR REPLACEMENT

Although the non-metallic springs used in the Feeder have outstanding life characteristics, failure may eventually occur, especially if the displacement is greater than normal. The symptoms of such failure will be:

1. Erratic behavior of the unit, or
2. Greatly reduced displacement.

If spring failure is suspected, the tuning spring stack should be removed by removing the six bolts attaching it to the body and the tie bar (see Figure 4).

Carefully examine each tuning spring for signs of delamination or breakage, especially in the area next to the spring shims. A failed spring can be recognized by the appearance of the spring surface. If this surface is discolored or has a patchy whitish appearance,

perhaps accompanied by surface burying or other irregularity, the spring is defective and should be replaced with a new spring ordered from the parts list.

NOTE: After any spring change or replacement, it is very important that the moving plunger be checked for alignment in the bore of the body casting. To do this, remove the coil through the rear of the unit. Now inspect the position of the plunger. If the plunger is off center in the bore hole, first loosen the six spring bolts again, then insert a screwdriver in the narrow gap and pry the plunger until it becomes centered. Leave the screwdriver in place and tighten the six spring bolts. The plunger is now correctly centered and unit can be reassembled

# Repairs (cont.)

If the feeder still exhibits signs of spring malfunction after the tuning spring has been checked and replaced, check the two cylindrical elastomer springs (see Figure 5).

1. First, remove the spring lever arms and the tuning spring stack.
2. Lay the unit on its side, making sure that the gap spacers stay in place, and use a small hammer and flattened round bar or dowel to tap the elastomer spring out of the body housing. Next, support the tiebar with a small block between the tiebar and work surface, and tap the spring out of the tiebar.
3. Carefully examine both springs for signs of failure and replace if such signs are found. A failed spring will exhibit one or more of the following characteristics:
  - (a) Looseness of the spring combined with signs of rubbing or abrasion at the outer surface of the cylinder. Looseness of the metal sleeve.
  - (b) Small crack in the elastomer around the end of the metal sleeve, possibly with small abraded particles of the elastomer present.
  - (c) Tackiness of the elastomer around the metal sleeve and at the outer surface of the cylinder, possibly with some outward bulging of the elastomer.

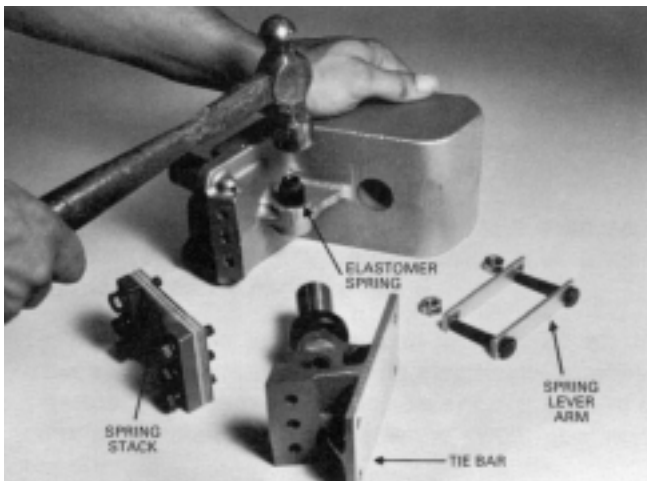

FIGURE 5

4. In replacing the elastomer springs, lay the unit on its side so that the chamfered ends of the spring holes are up. After making sure that the holes and their chamfered ends are clean and free from obstructions, lubricate the elastomer spring with a solution of water and 10% of liquid dishwasher soap (never use a petroleum lubricant) and press them partly into place with the thumbs. Then tap the springs back into place, again using the small supporting block between tiebar and work surface. Make sure that the springs go in straight and protrude equally at both ends of both spring holes.
5. Replace the lever arms, tightening the two fastening bolts securely.

## COIL REPLACEMENT

The coil in a vibratory feeder may eventually fail due to over-voltage or normal aging.

The following procedure should be followed in removing and replacing the electrical assembly, which includes the coil:

1. Remove the locking hex nut at the back of the unit.
2. Remove the four bolts securing the backplate of the electrical assembly to the body.
3. Lift out the electrical assembly. Unscrew and remove the adjustable plunger (see Figure 6).

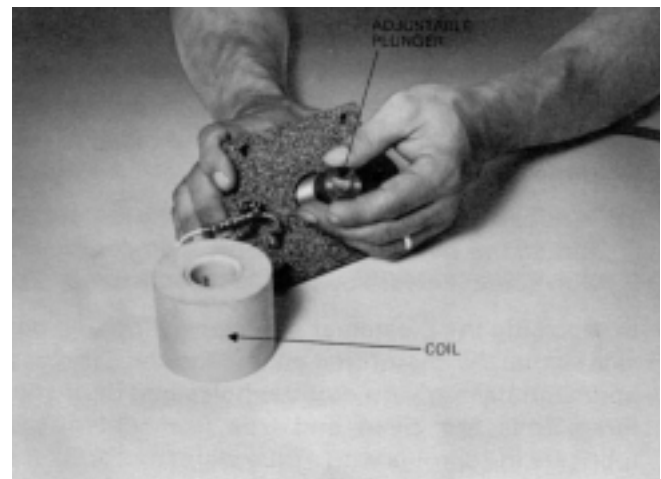

FIGURE 6



# Repairs (cont.)

4. Screw the adjustable plunger into the backplate of the new electrical assembly. Place the coil over the plunger and slide the assembly, with the power cord at the bottom, into the feeder body (see Figure 7).
5. Replace the four bolts in the backplate, tune the feeder as described in "Tuning by Plunger Adjustment" and tighten down the locking hex nut.



FIGURE 7

## THE HI-VI MAGNETIC DRIVE CIRCUIT

Old-style electromagnetic equipment has an inefficient attract-release type operation, where a mass mounted on springs is attracted by a DC electromagnet and returned to its original position solely by the springs. The new Hi-Vi method incorporates a lifetime permanent ceramic magnet and is operated directly from an alternating current line.

In the Hi-Vi method, the spring-mounted mass is alternately both attracted and repelled by an AC electromagnet assisted by the springs.

Intermeshing a fixed polarity permanent magnet with an alternating polarity AC electromagnet eliminates the rectifier since you would have an alternating attracting and repelling force as the polarity of the electromagnet alternated.

It will be noted that the pole pieces of the permanent magnet are intermeshed in the air gaps of an electromagnet. The polarity of the permanent magnet is fixed; the polarity of the electromagnet alternates at the line frequency. We have shown the polarity of the electromagnet as it would exist on one side of the sine wave. Note that both poles of the permanent magnet are being attracted toward the unlike electromagnet poles. They are also being repelled in the same direction by the like electromagnet poles. This results in four forces accumulating to drive the armature in the same direction. It also results in closing the magnetic circuit through the electromagnet providing a magnetizing effect on the permanent magnet on each side of the sine wave. The demagnetizing force is very minor for the attracting force and the magnetic lines of flux would much prefer to be attracted than repelled. This always tends to place the permanent magnet in a magnetizing circuit regardless of where the AC current is on the sine wave. As the polarity of the electromagnet changes, all of the forces are reversed and the permanent magnet armature is driven in the opposite direction.

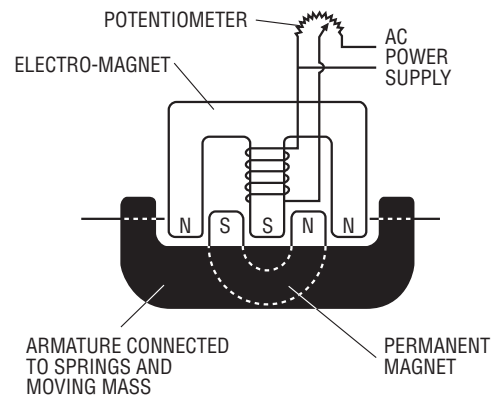

FIGURE 8

# Troubleshooting

TABLE 2. SERVICE CHART

NATURE OF PROBLEM		Misapplication	Tampering or Changing of Base or Tray	Loose Spring Clamp or Tray Mounting Bolts	Coil Failure	Control Failure	Incorrect Voltage	Spring Failure	Foreign Material Between Tray & Reaction Mass	Incorrect Tuning	Poor or Broken Weld on Tray	Incorrect Factory Adjustment	Sympathetic Vibration in Other Equipment	In Contact with Other Equipment	Line Voltage Variation	Blown Fuse or Circuit Breaker	Other Electrical Connections	Shockmount Deterioration	Corrosive or Abrasive Material	Product Variation
		1	2	3	4	5	6	7	8	9	10	11	12	13	14	15	16	17	18	19
Initial Installation	Reduced or Low Output	1	2			5	6	7	8	9				13	14		16			19
	Noisy but Output Okay		2	3					8	9	10	11	12	13						
	Noisy Certain Periods Only													13	14					
Develop After Satisfactory Initial Operation	Completely Inoperative		2		4	5		7						13		15	16			
	Operating But Reduced Output		2	3		5	6	7	8	9	10		12	13	14		16	17		19
	Output Okay Too Much Noise		2					7	8	9	10		12	13	14					
	Gradual Fading					5		7	8	9	10			13						19
	Excessive Tray Wear																		18	
	Turbulent Flow										10							17		
	Inconsistent Output		2	3		5	6	7		9	10		12	13	14		16	17		19

## 1. Misapplication

Feeder too small. Product difficult or impossible to handle. Impossible temperatures or atmospheres. Impossible dimensional requirements. Feeding requirements too precise or excessive. Consult Eriez.

## 2. Tampering or Changing of Base or Tray

Improper disassembly, extensions, covers, weights, screens or other modifications or attachments may have affected performance. Reassemble in accordance with printed instructions or consult Eriez.

## 3. Loose Spring Clamp or Tray Mounting Bolts

Tighten all bolts.

## 4. Coil Failure

Replace coil or coil and E-Frame assembly. Order from Eriez parts lists. Follow maintenance instructions carefully.

## 5. Control Failure

Check for burned out powerstat or rheostat, defective capacitor, defective switch, loose wiring, defective transformer (if used). Order new parts from Eriez. Possibility special control needed. Consult Engineering.

## 6. Incorrect voltage

Check nameplate specifications and line voltage.

# Troubleshooting (cont.)

- 7. Spring Failure**  
See maintenance instructions. Disassemble for examination. Tuning spring failure will show up as white areas. Order new parts from factory and replace per instructions.
- 8. Foreign Material**  
Examine and remove foreign material.
- 9. Incorrect Tuning**  
See maintenance instructions. To decrease displacement and output, use fewer or thinner tuning springs. To increase displacement and eliminate striking, use more or thicker tuning springs.
- 10. Poor or Broken Weld on Tray**  
Check and correct.
- 11. Incorrect Factory Adjustment**  
See maintenance instructions (gap adjustments.)
- 12. Sympathetic Vibration in Other Equipment**  
Check and correct.
- 13. Contact with Other Equipment**  
Check and correct.
- 14. Line Voltage Variation**  
Check and install voltage regulator if necessary.
- 15. Blown Fuse or Circuit Breaker**  
Check for short circuits and correct.
- 16. Other Electrical Connections**  
Check all connections and correct.
- 17. Shockmount Deterioration**  
Check and correct.
- 18. Corrosive or Abrasive Material**  
May require special tray. Consult Eriez.
- 19. Product Variation**  
If product density, moisture content or other characteristics vary, customer should take own corrective measures.

# Parts

1. TUNING SPRING
2. SPACER
3. TIE BAR
4. MOVING PLUNGER (ARMATURE)
5. BODY
6. ELASTOMER SPRING
7. ELECTRICAL ASSEMBLY

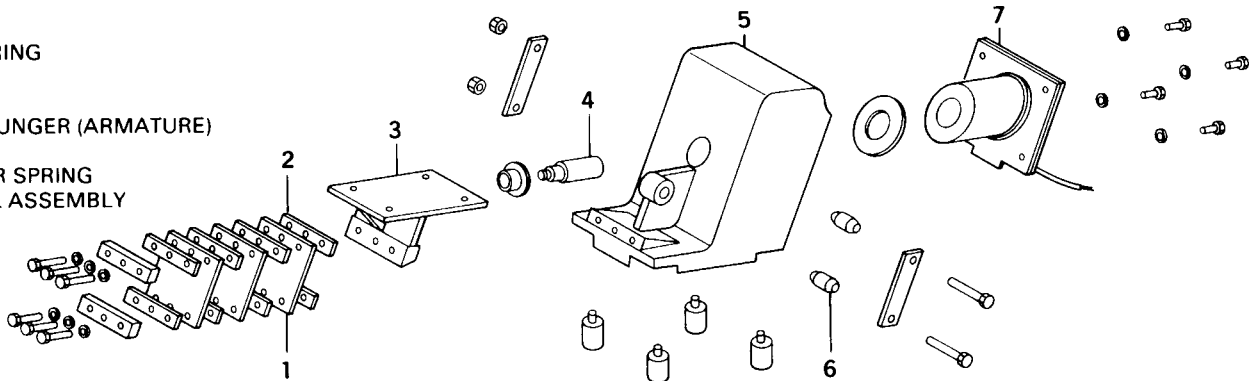

Eriez and Eriez Magnetics are registered trademarks of Eriez Manufacturing Co., Erie, PA

© 2001 ERIEZ MAGNETICS ALL RIGHTS RESERVED



**World Authority in Advanced Technology for Magnetic, Vibratory and Metal Detection Applications**

HEADQUARTERS: 2200 ASBURY ROAD, P.O. BOX 10608, ERIE, PA 16514-0608 U.S.A.

Telephone 814/835-6000 • 800/345-4946 • Fax 814/838-4960 • International Fax 814/833-3348

Web Site: <http://www.eriez.com>

e-mail: [eriez@eriez.com](mailto:eriez@eriez.com)

MANUFACTURING FACILITIES IN: AUSTRALIA • BRAZIL • CANADA • INDIA • JAPAN • MEXICO • SOUTH AFRICA • UNITED KINGDOM • UNITED STATES